

# Pin Header

Single / Dual Row; S.M.T Type

Pitch:2.54mm

# Series

460 25

**Odia** 奥比亚

Tel:(+86)0755-28248661/2/3

Fax:(+86)0755-27857873

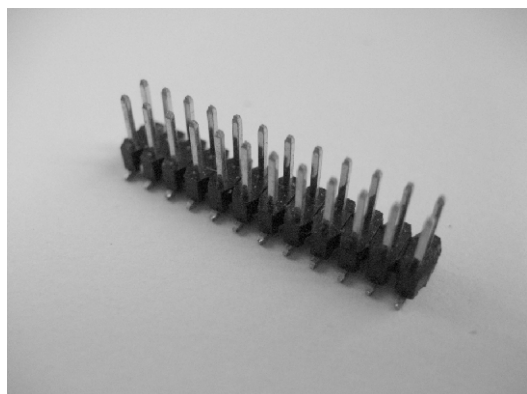

### SPECIFICATIONS (技术参数):

Current Rating (额定电流): 3.0 AMP  
 Contact Resistance (接触电阻): 30mΩ Max  
 Insulation Resistance (绝缘电阻): 1000MΩ Min  
 Withstand Voltage (耐压值): 600VAC/minute  
 Operation Temperature (工作温度): -40°C to +105°C

### MATERIALS(材质):

Contact Material (接触件材质): Copper Alloy  
 Contact Plating (接触件电镀): Gold or Tin over 50 μ "Ni  
 Insulator Material (绝缘体材质): Polyester(UL94V-0)  
 Standard: PBT

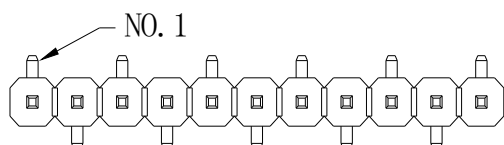

Single row - M1 Type

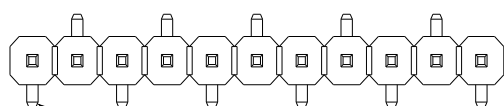

Single row - M2 Type

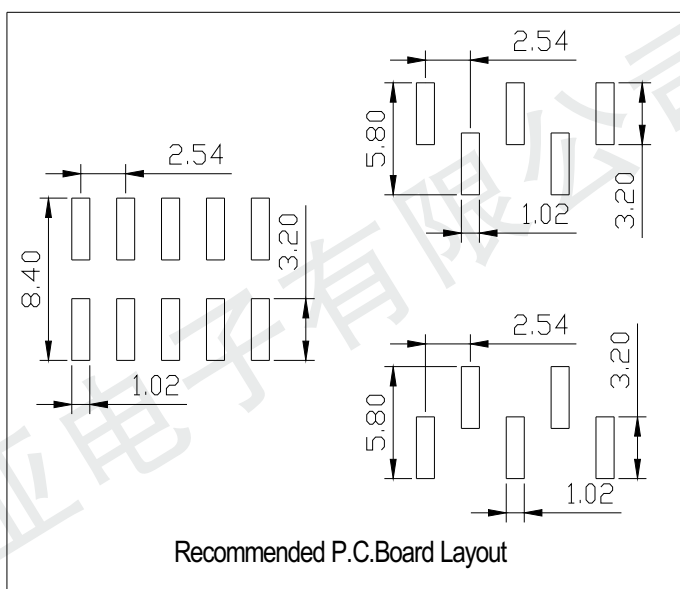

Recommended P.C.Board Layout

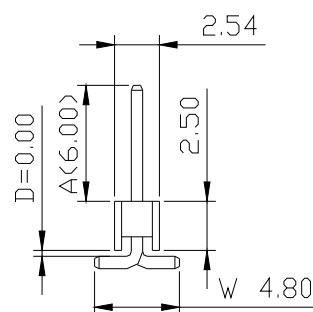
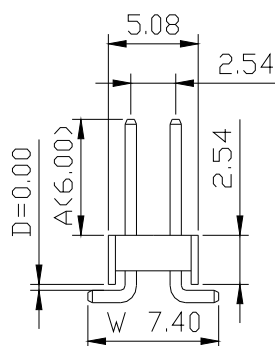
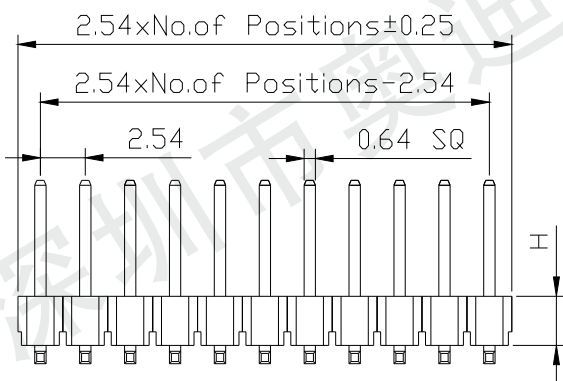

## Ordering Code

① ② ③ ④ ⑤ ⑥ ⑦ ⑧ ⑨ ⑩  
 460 25 1 2 50 M 2 4 1 XXX

① Series No.:  
 460= Pin Header

③ Insulator Height:  
 1 = 2.50mm  
 2 = 2.34mm  
 3 = 2.00mm  
 4 = 1.70mm  
 5 = 1.50mm

② Pitch: 25= 2.54mm

④ Number of row:  
 1=Sing row  
 2=Double row

⑤ Number of Contacts:  
 Single row=01(1x1)to 40(1x40)  
 Double row=04(2x2)to 80(2x40)

⑥ Tail & Mounting Style:  
 M=Straight SMT type

⑦ Contact Plated  
 0=Tin 1=Gold Flash  
 2=Gold 3u" 3=Gold 5u"  
 4=Gold 10u" 5=Gold 15u"  
 6= Gold 30u" A=Gold 1.5u"  
 B=Gold 2u"

⑧ Material Type  
 0=PPS 3=Nylon-9T  
 1=PBT 4=Nylon-6T  
 2=LCP 5=PA46

⑨ Tiers of Body  
 1 = Single tier  
 2 = Double tier  
 3 = Triple tier

⑩ Pin Length  
 XXX=A+H+D+(W/2)  
 XXX=A+H+D+(W-2.54)/2